

LANCER | BEER SYSTEMS

S4E Polaris V3 Superchiller™

240V / 50Hz

Installation, Operation & Service Manual



This page is intentionally left blank

Table of contents

1. Product Details	4
1.1 Model	4
1.2 Product Features	4
1.3 Specifications	4
1.4 Options	4
1.5 Ice Bank	5
2. Superchiller Safety Information	5
2.1 Safety Instructions	5
2.2 Recognise Safety Alert Symbols	5
2.3 Operating	5
2.4 Service & Maintenance	5
3. Installation	6
3.1 Receiving	6
3.2 Unpacking	6
3.3 Selecting a Location	6
3.4 Mounting Superchiller	7
3.5 Connecting Python	7
3.6 Plumbing the Drain	7
3.7 Filling Unit	7
3.8 Electrical Connection	7
3.9 Commissioning	8
3.10 Purge System	9
4. Thermostat – Carel Pjeasy – Thermostat Parameters	9
4.1 Thermostat Settings	9
4.2 Programming Instructions	9
5. Scheduled Maintenance	10
5.1 Scheduled Maintenance	10
6. Electrical Circuit Diagram	12
6.1 S4E Polaris V3 – Circuit Diagram	12
7. Airflow Diagram	13
8. Trouble Shooting	14
8.1 Refrigeration	14
9. Omni Icebank Control Test	15
11. Refrigeration & Body Assembly Parts List	16
11.1 13.1 Assembly Diagram	17
12. Certificate of Warranty	18
13. Manufacturer’s Checklist	19

1. Product Details

1.1 Model

31000231	S4E POLARIS V3 SPC54 4C 240/50
31000232	S4E POLARIS V3 SPK2-11 240/50
31000233	S4E POLARIS V3 SPC54 6C 240/50
31000236	S4E POLARIS V3 SPC54 240/50
31000237	S4E POLARIS V3 SPC54 SP-EVENTS
31002000	S4E POLARIS V3 SPC54 6C EVENTS
31002001	S4E POLARIS V3 SPC54 4C EVENTS
31000234	S4E POLARIS V3 SPC54 6C CCA
31000235	S4E POLARIS V3 SPK2-11 CCA
31000238	S4E POLARIS V3 SPC54 0C CCA
31000239	S4E POLARIS V3 SPC54 4C DOUGH
31000244	S4E POLARIS V3 SPC54 4C CCA

1.2 Product Features

The Lancer S4E Polaris V3 Superchiller is a refrigerated unit designed to maintain a liquid product temperature through the python and dispenser. When coils are fitted the unit will chill liquid products stored at ambient temperature. The superchiller has a range of two pumps with different flow rates and can be used in ice bank or Glycol operation.

1.3 Specifications

Version	SPC54	SPK2-11
Voltage	240 Volts	240 Volts
Frequency	50 Hz	50 Hz
Max Current Draw	5.6 Amps	7.0 Amps
Ambient Temperature	2 - 40°C	2 - 40°C
Max Product Pressure	10 BAR(145 PSIG)	10 BAR(145 PSIG)

Dimensions

Width	880 mm	880 mm
Depth	505 mm	505 mm
Height with 150mm legs	880 mm	1005 mm

Weight

Shipping	90 kg	114 kg
Empty	82 kg	109 kg
Operating	157 kg	179 kg
Refrigerant	800 Grams R134a	800 Grams R134a
Tank	72 litres	72 litres
Ice bank Weight	18 kg	N/A – glycol use only
Construction	Stainless Steel	Stainless Steel

1.4 Options

- Legs are standard; Optional casters

1.5 Ice Bank

All S4E Polaris V3 Superchiller units are suitable for ice bank operation as an alternative to glycol / water. Simply fill tank with water, no other changeover is required.

2. Superchiller Safety Information

2.1 Safety Instructions

For your personal safety, and that of others working around you please read, understand, and follow thoroughly all safety instructions included in this manual and on the superchiller.

- Review all applicable OSH (Occupational Safety & Health) regulations.
- Review all applicable Beverage Dispensing Gas Standards
- Learn how to operate the superchiller and use the controls properly.
- Do not allow untrained personnel to operate the machine.
- Ensure that the superchiller is maintained according to service manual instructions.
- Do not allow any unauthorised modifications to the machine.

2.2 Recognise Safety Alert Symbols

The safety alert symbol precedes Warning and Caution notes throughout this manual. To prevent personal injury or damage to the machine these alerts must be strictly adhered to.

	Warning	Alerts to a potentially hazardous situation that if not avoided CAN result in death, serious injury.
--	----------------	---

	Caution	Alerts to a potentially hazardous situation that if not avoided MAY result in injury or equipment damage.
---	----------------	--

2.3 Operating

	Warning	Superchillers are intended for indoor operation only; do not operate outside unless suitably protected by a weatherproof enclosure. This appliance is not suitable for installation in an area where a water jet could be used.
---	----------------	---

	Caution	This appliance is not intended for use by persons (including children) with reduced physical, sensory or mental capabilities, or lack of experience and knowledge, unless they have been given supervision or instruction concerning use of the appliance by a person responsible for their safety. Children should be supervised to ensure that they do not play with the appliance.
---	----------------	---

2.4 Service & Maintenance

	Caution	Installation of superchiller and service work should only be performed by fully trained & certified Electrical, Plumbing, & Refrigeration Technicians.
---	----------------	--

**Warning****ALL WIRING AND PLUMBING MUST CONFORM TO LOCAL AND NATIONAL CODES.****Warning****SUPERCHILLER MUST BE ISOLATED FROM ELECTRICAL SUPPLY BEFORE COMMENCING ANY SERVICE OR MAINTENANCE WORK.**

3. Installation

**Warning****To avoid personal injury or damage, do not attempt to lift a superchiller without help. Use of a mechanical lift is recommended.**

3.1 Receiving

Each unit is completely tested under operating conditions and thoroughly inspected before shipment. At time of shipment, the carrier accepts the unit and any claim for damage(s) must be made with the carrier. Upon receiving units from the delivering carrier, carefully inspect shipping crate for visible indication(s) of damage. If damage exists, have carrier note damage on bill of landing and file a claim with the carrier.

3.2 Unpacking

**Caution****The use of gloves is recommended to protect hands from potential injury from sharp edges. The superchiller must always be handled in a vertical position.**

Carefully unpack the Lancer S4E Polaris V3 Superchiller from the shipping carton, remove the wooden base.

If appropriate, assemble legs to unit by carefully tilting (tilt should not be more than 45°).

Inspect unit for concealed damage and if evident, notify delivering carrier and file a claim against the carrier.

3.3 Selecting a Location

**Warning****Superchillers are intended for indoor operation only; do not operate outside unless suitably protected by a weatherproof enclosure.****This appliance is not suitable for installation in an area where a water jet could be used.****This appliance is only to be installed in locations where its use and maintenance is restricted to trained personnel.****Caution****The superchiller is not suitable for use in subfreezing temperatures.****To prevent damage to the water supply line, turn off and drain unit when air temperature is below zero.**

- The superchiller should be located in a well-ventilated, firm, level location close to dispenser, water and electrical supplies, with easy access for servicing
- SPC version superchillers are intended for use in the bar area.

- SPK2-11 version superchillers are intended for use in a non temp controlled storage area.
- Ensure sufficient clearance around superchiller to allow good fresh air circulation through the condenser – allow at least 200mm at rear, sides and top, with the front unobstructed.
- Installation should only be performed by a qualified and competent technician.

3.4 Mounting Superchiller

- Install on a flat, level surface using adjustable legs or casters (Optional).



Caution

Superchiller operational weight is 157/179kg; ensure that all supporting structures are certified for this loading by a registered Mechanical Engineer. Supporting structure must be securely fixed to floors or walls.

3.5 Connecting Python

Connect Python to Superchiller and Dispenser.



Caution

NOTE: The superchiller is rated to operate with a maximum of 30m of python connected. Exceeding manufacturer's ratings may cause damage to the superchiller and void warranty.

Python Details

Recirculation Lines ½" Dia Glycol tubing

Beer Lines: Max 6-off 3/8" Dia Beer line tubing

Beer line connections are made on top of the tank onto John Guest 3/8" Superseal flowbend connection.

3.6 Plumbing the Drain

The 13mm elbow exiting from the RH Pump Panel of the unit should be plumbed to a suitable drain, installation in accordance with AS/NZS 3500.1 and AS/NZS 3500.2.

3.7 Filling Unit

Glycol - Remove superchiller lid and fill the tank with glycol/water mixture of 30% (refer to chart in Section 5 for details) until mixture flows out of the overflow.

Water - If the unit is to be used as an ice bank, simply fill with clean water until it flows out the overflow tube.

3.8 Electrical Connection

- This unit is connected to the supply via a flexible cord fitted with a 3 pin plug.
- Check the name plate on the machine for electrical supply requirements. Use only the power supply specified on the name plate.



Warning

If the supply cord is damaged, it must be replaced by the manufacturer, its service agent or similarly qualified persons in order to avoid a hazard.



Warning

To avoid possible fatal electric shock or serious injury the superchiller must be electrically grounded. Electrical Connection Must Be Made In Accordance With The Appropriate Local Codes And Regulations. Use of an RCD is recommended.

3.9 Commissioning

- Connect superchiller power supply lead to an appropriate 3 pin socket outlet and switch on. Compressor, condenser fans and pump/agi motor should all operate.
- On initial start up, remove the pump plug to allow the tank temperature to reduce without the unit cutting out on overload. If the unit cuts out during pull down, turn off at mains socket to reset then continue to pull down as before.
- Once the unit is cycling normally, the pump plug should be replaced, ensure the pump is running.
- Allow lines to fill. Ensure liquid level does not drop below pump intake during initial filling of the python.
- As required top up the unit.
- Check all connections for leaks.
- Fully insulate all chilled lines and ensure air tight at all connections.
- Before running unit, sanitise product lines using beer line cleaner.

Glycol Units:

- Check water / glycol mixture with refractometer (refer to chart Section 5.1 for details).
- Check the set point of the controller (reset per Section 4)
- Monitor the indicated temperature on the thermostat and ensure temperature reduces to the set point.
- Don't leave water in coils as the water will freeze.
- Polaris chillers are configured to allow either ice bank or glycol operation with no change to the control system.
- If filled with water the system will operate on the ice bank control and as the water temperature will never drop below zero the thermostat will display the tank temperature only.
- If filled with a glycol solution the system will cycle on the thermostat settings as the ice bank control probe normally needs to be embedded in ice to turn off.
- The operation of the ice bank / level control board (83000278) as used on Polaris chillers relies on the tank fluid conductivity being within a defined range.
- When used as a glycol chiller the tank temperature is controlled by the thermostat, however the ice bank control provides HP protection to the refrigeration system and low fluid level protection.
- Using low conductivity (pure) water and high glycol concentration can result in the fluid conductivity being outside the parameters that will allow the control to operate correctly.
- Aqueous glycol solutions lower their conductivity as the temperature is reduced and the higher the glycol concentration the more pronounced the effect.
- Several instances have been reported where the refrigeration will not turn on until the glycol fluid has reached much higher temperature than suggested by the set point of the thermostat.
- A basic test for tank fluid conductivity can be done using a Total Dissolved Solids (TDS) or Conductivity meter.
- A TDS of 100 to 200 is recommended. (100 – 300 uS/cm using a conductivity meter)
- If the TDS is below this level add two tablespoons (approx. 40 grams) of carb soda, allow this to circulate, and dissolve then recheck TDS. If needed add further carb soda to achieve the desired TDS reading

3.10 Purge System

- Progressively activate each fount connected to the superchiller systems to achieve an uninterrupted flow of product.

4. Thermostat – Carel Pjeasy – Thermostat Parameters



4.1 Thermostat Settings

Parameter	Type	Def	Description
St	Set point	-2.0	Refrigeration will turn off when glycol reaches this temperature.
rd	F	1.0	Temperature differential, glycol temperature will increase from the cut out point by this value before the refrigeration turns on.
AF	F	-5.0	Antifreeze alarm set point. If the evaporator suction line reaches this temperature the control will stop the refrigeration system and will require a manual reset. Antifreeze alarm can be reset by holding “UP” and “DOWN” keys for 5 seconds. In case of probe 2 failure, the antifreeze alarm function is inhibited and regulation is still performed. If “AF parameter is set to its minimum value the alarm function is inhibited.
rt	F	**	Time (in hours) of max/min temperatures logging.
rH	F	**	Highest/ maximum recorded temperature.
rL	F	**	Lowest/ minimum recorded temperature.
AH	F	20.0	High temperature alarm (relative to set point).
AL	F	4.0	Low temperature alarm (relative to set point).
c2	F	3 mins	Minimum time in mins after turning off before the control will give an output to the refrigeration solenoid (short cycle protection).
r4	F	7.0	Value to increase the set point in ECO mode.
r2	F	5.0	Maximum allowed set point.
r1	F	-5.0	Minimum allowed set point.

Controls programmed during manufacture.

All other non used parameters are hidden to avoid confusion.

4.2 Programming Instructions

4.2.1. Set Point

Push and hold the “SET” key, “st” is displayed then the current set point is displayed and flashes, release “SET” key to change the set point value.

Push the “UP” or “DOWN” arrow keys to change the set point value.

To accept the new value press the “SET” key or wait 60 seconds without pressing any keys for the unit to time out.

4.2.2. Other Parameters

Push and hold the “SET” key, until “rd” is displayed.

- Select the required parameter to change using the “UP or “DOWN” arrow keys then press the “SET” key to display its value.

- Press the “UP” or “DOWN” key to change its value.
- Press the “SET” key to store the new value and move to the next parameter.

To exit from programming mode press the “SET” key for 3 seconds or wait 60 seconds without pressing any keys for the unit to time out.

4.2.3. Eco Mode

In the ECO mode an offset is added to the Set point: “St” + “r4”.

To set the ECO mode press and hold the “UP” key, “on” or “oF” is displayed showing how ECO mode will be changed, when “on” or “oF” disappears release key. In ECO mode “Ec” is displayed alternated to probe 1, Glycol temperature actual value.

4.2.4. Alarm Signals

When an alarm is activated, the display shows the corresponding message that flashes alternating with the temperature.

Message	Cause	Reset
“E0”	Glycol Probe Failure	Automatic
“E1”	Refrigeration Line Probe Failure	Automatic
“LO”	Low Temperature Alarm	Automatic
“HI”	High Temperature Alarm	Automatic
“AF”	Antifreeze Alarm	Manual Antifreeze alarm can be reset by holding “UP” and “DOWN” keys for 5 seconds.

5. Scheduled Maintenance



Warning The superchillers must not be cleaned by a water jet.

The following superchiller routine maintenance should be performed at the intervals listed.

5.1 Scheduled Maintenance

5.1.1. Weekly

- As per brewery instructions, ensure weekly sanitisation of the whole beer system is carried out, including keg couplers, beer lines, chiller coils, pythons, founts and taps.

5.1.2. Monthly

- Disconnect the machine from the power supply.
- Remove the condenser filter and rinse in warm soapy water.
- Re-install the condenser filter.
- Check the tank level. Fill if necessary.
- Check operation of pump.
- Check for beer leaks.
- If Glycol type, inspect and if contaminated replace with 30% Glycol and 70% Water mix.
- Check concentration with a refractometer. (see chart below)

- Reconnect the machine to the power supply.

Relative freeze points and refractometer readings for propylene glycol / water mix

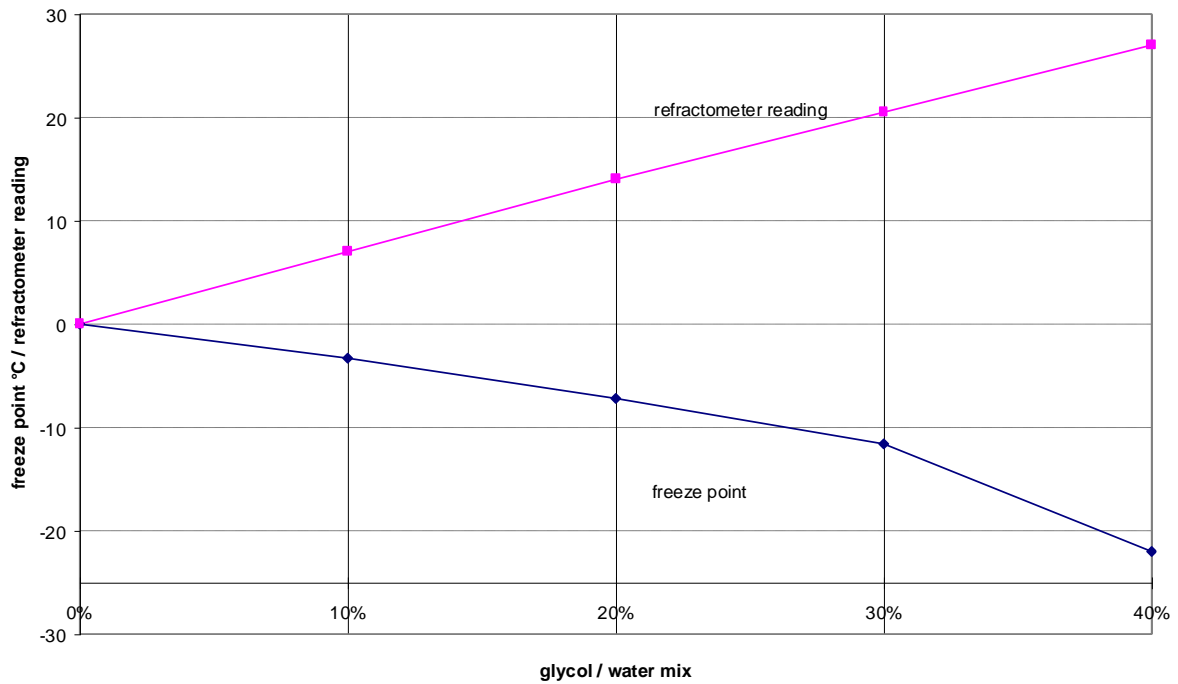

5.1.3. Yearly

- Disconnect the machine from the power supply.
- Check interior of the tank, clean product coils and evaporator if necessary to remove any accumulated deposits.
- Check pump operation
- Inspect agitator blade for deposits and wear.
- Reinsert overflow tube and re-fill tank with water or Glycol/water mix per above.
- Reconnect power supply and start machine.

6. Electrical Circuit Diagram

6.1 S4E Polaris V3 – Circuit Diagram

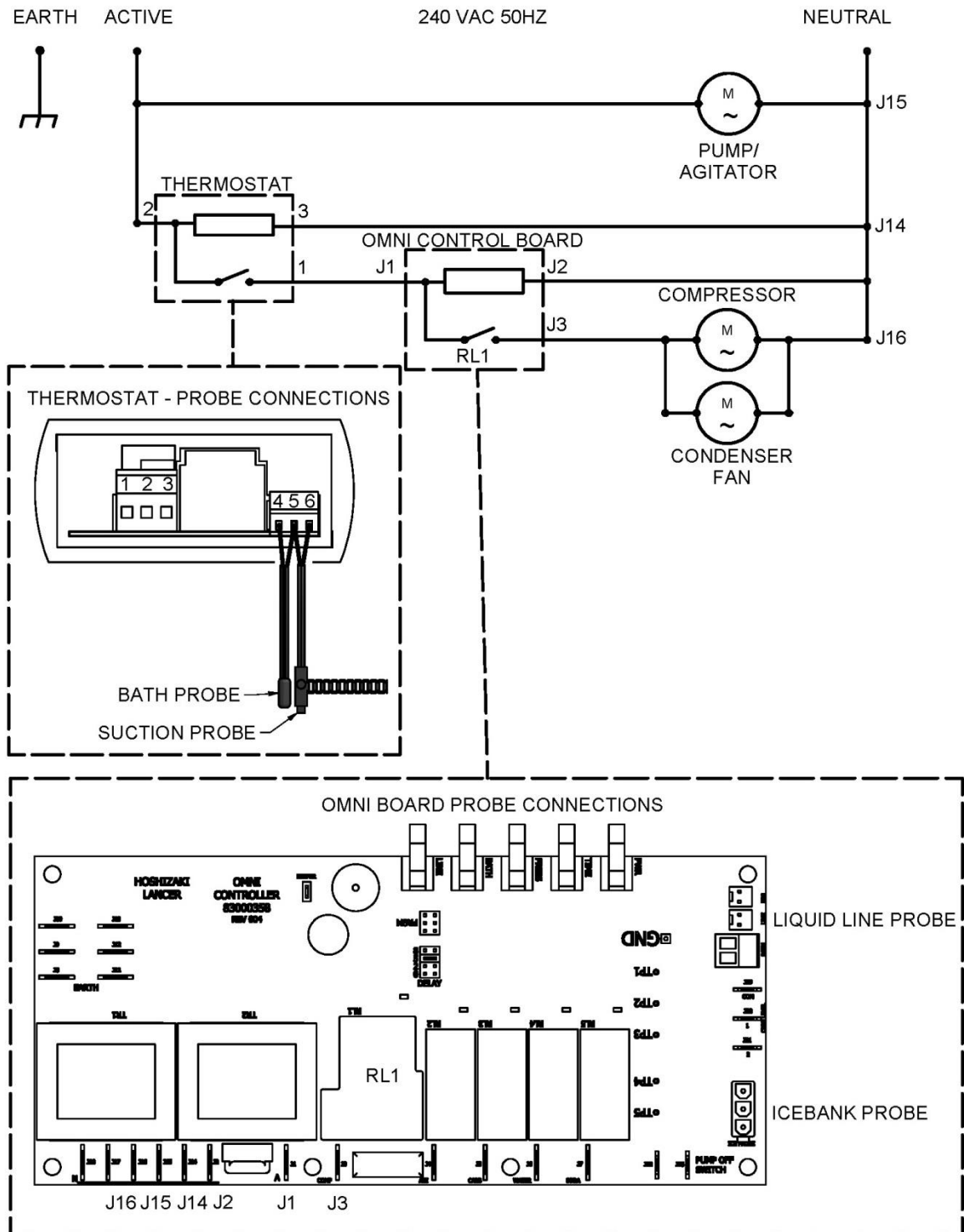

7. Airflow Diagram

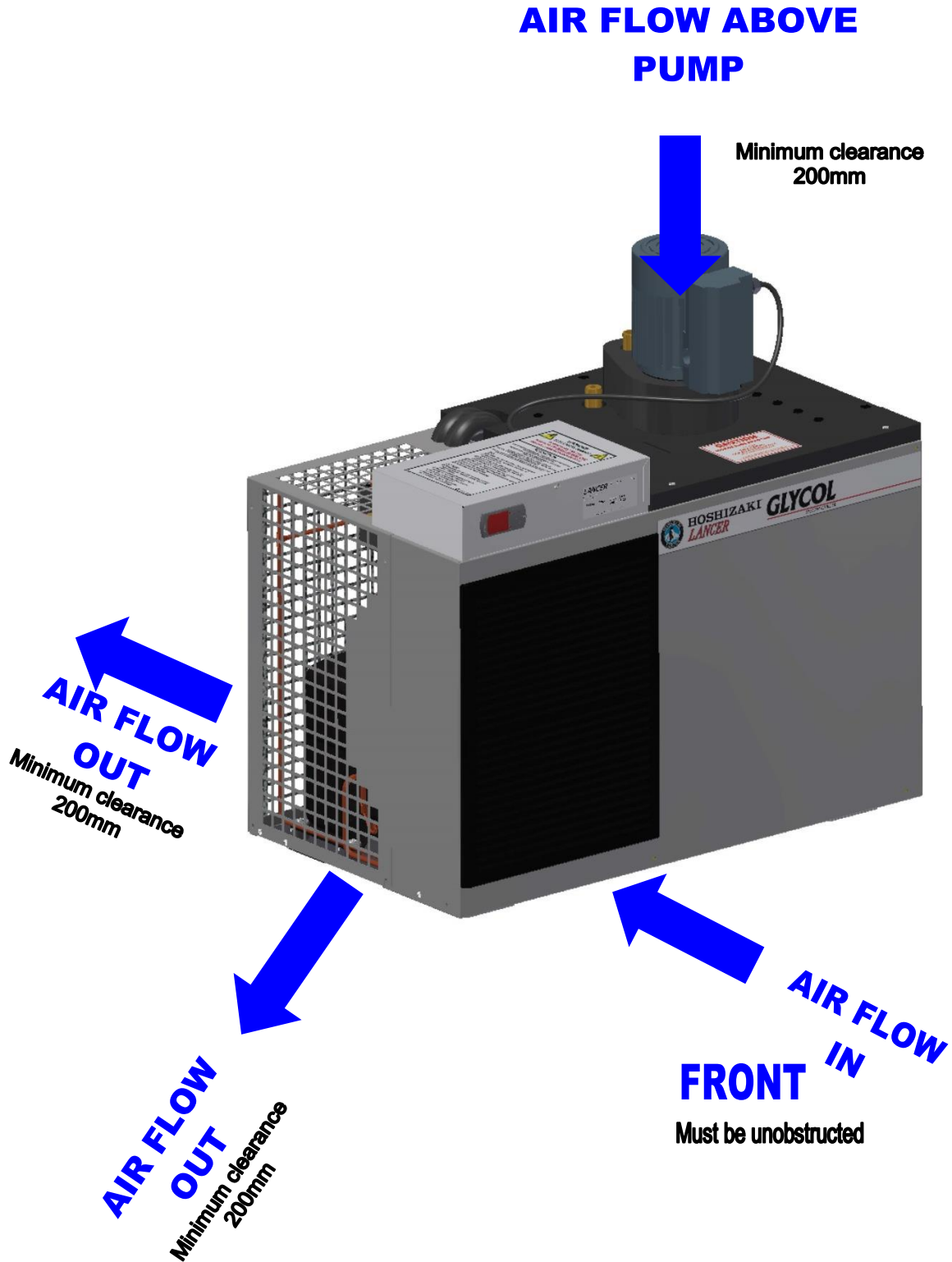

8. Trouble Shooting

8.1 Refrigeration

TROUBLE	CAUSE	REMEDY
Compressor will not start.	<p>Power Failure.</p> <p>High Pressure temperature switch activated. LED on Ice Bank Control board illuminated.</p> <p>Ice bank control faulty contacts not closing. Low tank level.</p> <p>Check compressor start mechanism components.</p> <p>Thermal overload faulty, open, circuit compressor seized, contactor faulty.</p>	<p>Check for blown fuse, supply cord pulled out or supply outlet turned off.</p> <p>Turn superchiller "off" at supply socket then "on" again to reset controller.</p> <p>Check Ice bank control using Procedure in Section 9. Replace control or probe if defective.</p> <p>If faulty, replace e.g. capacitors, start relays.</p> <p>Replace compressor, check condenser, check power supply, evacuate system and if necessary fit burnout drier to industry standards.</p>
Compressor short cycling on thermal overload (frequent starting and stopping of the compressor while control contacts remain closed).	<p>Dirty condenser.</p> <p>Restricted air flow over unit.</p> <p>Low supply voltage.</p> <p>Defective thermal overload.</p> <p>Check wiring connections.</p> <p>Fan motor bearings tight or seized.</p>	<p>Clean condenser of all lint and dirt.</p> <p>Check for air restriction to condenser.</p> <p>Check with voltmeter.</p> <p>Replace compressor.</p> <p>Tighten if loose.</p> <p>Replace motor(s)</p>
Product too warm	<p>Control defective (permanently open circuit).</p> <p>Low refrigerant charge.</p> <p>Check agitator motor, seized or fused.</p>	<p>Check Carel control using procedure in Section 5. If icebank, Section 9. Replace control or probe if defective.</p> <p>Leak check, repair leak, charge with correct amount of refrigerant.</p> <p>Replace if not working.</p>
Compressor runs too long or doesn't cycle.	<p>Location too hot.</p> <p>Superchiller overloaded.</p> <p>Loss of refrigerant.</p> <p>Condenser clogged.</p> <p>Fan not operating.</p> <p>Inefficient compressor</p>	<p>Relocate or improve ventilation.</p> <p>Use larger model, or reduce python length.</p> <p>Leak check and repair.</p> <p>Clean off dust, line, grease, etc.</p> <p>Remove obstruction or replace motor.</p> <p>Replace</p>

9. Omni Icebank Control Test

This is a test to simulate the building and erosion of the icebank; to determine if the icebank control is operating correctly. The test assumes that all other components in the refrigeration system (e.g. high pressure cut-out reset) are in an operational condition.



Warning

**230VAC is present on PC Board.
Work should only be performed by fully trained & certified
Electrical, Plumbing & Refrigeration Technicians.**

1. Remove the ice bank probe at the PC Board.

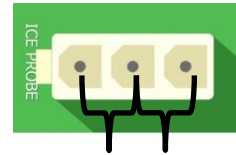

2. Jumper the three terminals as shown. Use a spare male connector with wiring if available. The compressor relay should close and refrigeration system start.

(Simulates water covering all probes)

3. With refrigeration system operating (compressor relay energised) remove the jumper from the centre terminal. Refrigeration system should continue to operate.

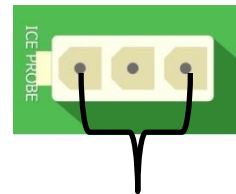

(Simulates ice growth over green probe. Water still contacting red and black probes)

4. Remove the remaining jumper. The compressor relay should open and the refrigeration system should stop.



(Simulates ice growth over the probes)

10. Refrigeration & Body Assembly Parts List

Ref.	Parts No.	Description
1a	78000116	SPC54 PUMP WITH AGI
1b	78000049	SPK2-11 HARD WIRED ASSY
2	79186786	SUPERSEAL FLOW BEND CONN 3/8
3	85000123	LID S4E POLARIS V3
4	85000125	HATCH INSPECTION S4E POLARIS V3
5	63000220	COIL S4E POLARIS V3
6	61000765	ELECT BOX LID S4E POLARIS V3
7	80000125	CONDENSER ASSY S4E V3
8	64000399	BASE ASSY S4E POLARIS V3
9	83000220	LEAD POWER SUPPLY S4E
10	83000358	CONTROL LEVEL I/B OMNI
11	83000184	PJEASY OEM CONTROL KIT
12	80000124	CONDENSOR FAN ASSY
12a	80000123	EBM FAN MOTOR
13	83000282	COMPRESSOR CONTROL BOX
14	64000100	ICE PROBE ASSY S4E POLARIS
15	95000642	LOUVRE KMD-0101AA
16	87000102	RECEIVER DRIER
17	79001043	CAP CAMLOCK 3348 GP
18	62000300	EVAPORATOR ASSY
19	87000129	TX VALVE HONEYWELL
20	80000073	COMPRESSOR (WITH CONTROL BOX)
21	79232218	LEG
22	61000762	PANEL FRONT S4E POLARIS
23	61000760	PANEL REAR S4E POLARIS
24	61000761	PANEL GRILL S4E POLARIS
25	95000641	CONDENSER FILTER
26	83000209	PROBE NTC STRAP ON
27	83000369	PROBE NTC RUGGEDIZED
28	83000091	PROBE NTC (BULB END)

10.1 Assembly Diagram

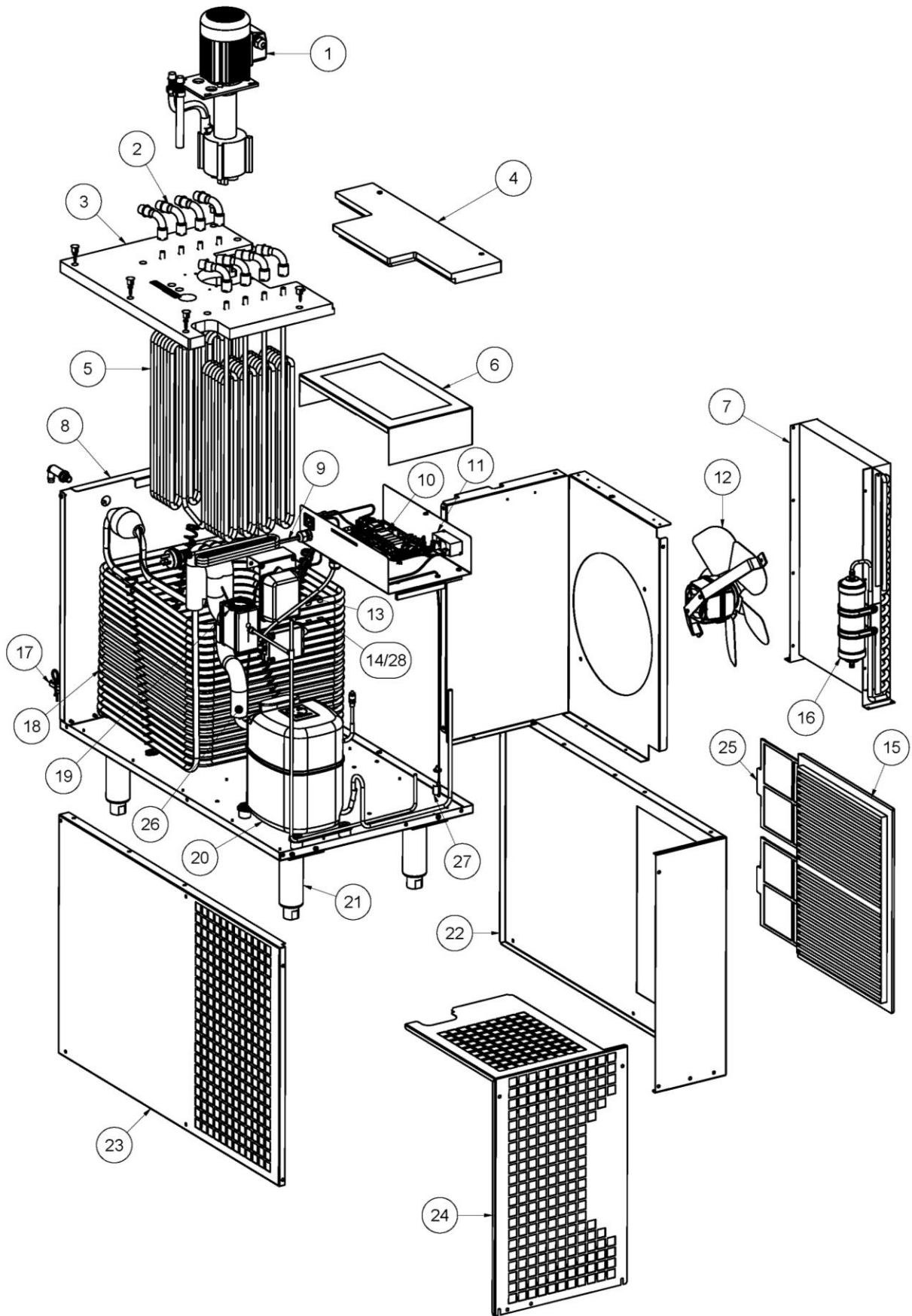

11. Certificate of Warranty

It is the policy of Hoshizaki to provide to its current customers, warranty for all equipment supplied and installation work performed within a specified period.

Parts and Equipment

Lancer provides a warranty period of twelve (12) months from the date of original invoice for all manufactured parts. Repair or replace of defective parts will be at the sole discretion of Lancer.

Changeover parts will be invoiced to the customer at the customers normal purchase cost and upon return of the warranty item and validation of the claim, the invoice will be credited.

Installations

Lancer provides a warranty period of twelve (12) months from the date of final invoice for workmanship after the completion of any installation work, provided the parts and labour are completed by Lancer or its subcontractor.

Labour

Lancer will not normally cover any labour costs associated with a warranty claim. Subject to the approval of the Divisional Sales Manager, Lancer may choose to reimburse the customer for some or all labour costs associated with a warranty claim. Any claim for labour costs must be authorized by Lancer prior to the work being undertaken.

Exclusions

Lancer will not accept any liability or cost associated with any consequential losses (such as loss of syrup or beer), loss of profit or damage to property as a result of faulty product.

Warranty shall not apply:

- a) If in the opinion of Lancer, the equipment has been used in a situation the equipment has not been designed for;
- b) If in the opinion of Lancer, the equipment has been subject to abuse, negligence or accident;
- c) If connected to improper, inadequate or faulty power, water or drainage service or operated using incorrect, insufficient or contaminated lubricants, coolants, refrigerants or additives;
- d) Where the product is installed, maintained or operated otherwise than in accordance with the instructions supplied by Lancer;
- e) Where the product has been damaged by foreign objects;
- f) Where the product has been serviced, repaired, altered or moved otherwise than by Lancer or its nominees or using other than Lancer approved replacement parts.

12. Manufacturer's Checklist

Checked by Date

.....

Gas Charge Icebank Probe fitted

Electrically tested by Refrigeration tested by

TAG No.

- High temperature probe located on liquid line between coil and receiver / dryer
- Compressor wiring connections label affixed, wiring checked and label signed
- Refrigeration system final check. Ensure evaporator fully frosts.
- Check all tube work for rubbing e.g. discharge line, liquid line, TX capillary.
- Condenser not touching divider panel or grille.
- Agitator blades tight and not touching coils cradle.
- Overflow pipe correct height and positioned straight.
- All motors and pumps secured and mounted correctly.
- Check icebank and temp probe position and tightness.
- Coils in cradle correctly and spaced.
- Superchiller sticker correctly positioned and straight.
- Attention sticker fitted and correctly positioned.
- Clean exterior of unit including power cords.
- Warning sticker applied
- Check air filters are fitted
- Check body for sharp edges.
- Check lid for cleanliness and rough edges. Fit and secure.
- Copy checklist & file, put manual/checklist in plastic bag & place in the tank area.
- Customer asset No.

W/O

