



A HOSHIZAKI Company

Siberian™ Energy Saving Glycol Chiller with Variable Speed Drive Technology

230V/50Hz

Installation, Operation & Service Manual



Table of Contents

1. Specifications and Features	3
1.1 Model	3
1.2 Specifications	3
1.3 Product Features	3
1.4 Pump curve	4
2. Safety Information	4
1.5 Safety Instructions	4
1.6 Recognize Safety Alert Symbols	5
1.7 Operating	5
1.8 Service & Maintenance	5
3. Installation instructions for:	6
31000254 SIBERIAN 5 KW R404 SPKE2-11/8 or 31000254 SIBERIAN 5KW R404 SPKE2-11/8	6
1.9 Receiving	6
1.10 Unpacking	6
1.11 Selecting a Location	6
1.12 Connecting to the Venue's Glycol Cooling System	7
1.13 Refrigeration Connection	7
1.14 Electrical Connection	9
1.15 Filling Unit with Glycol / Water	10
1.16 Commissioning	10
4. Installation Instructions for: 78000136 KIT C/O SPKE211 VSD SUIT SIB	11
5. Operation	11
6. Scheduled Maintenance	16
5.1 Monthly	16
7. Electrical Circuit Diagram	17
8. Diagrams & Parts	18
9. Trouble Shooting	20
10. Certificate of Warranty	21
11. Manufacturer's Checklist	23

1. Specifications and Features

1.1 Model

31000254 SIBERIAN 5KW R404 SPKE2-11/8
31000255 SIBERIAN 3KW R404 SPKE2-11/8
78000136 KIT C/O SPKE211 VSD SUIT SIB

1.2 Specifications

Power Supply

Supply Voltage	230 Volts
Supply Frequency	50 Hz
Supply Fuse size	6A min – 10A max

Dimensions

Width	590mm + 40mm overflow
Depth	590 mm
Height	1270 mm

Tank Operating Capacity	140 L
--------------------------------	-------

Weight

Shipping	75 kg
Empty	62 kg
Operating	202 kg

Pump

Motor power rating	370 Watts (W)
Maximum Ambient Temperature	40°C
Maximum Operating Pressure	13.5 Bar

Refrigerant Connections

Suction Line	28.5mm
Liquid Line	9.5mm

Refrigerant	R404a
--------------------	-------

Options

Cooling Cassettes	3 kW, 5 kW
-------------------	------------

1.3 Product Features

The Lancer Siberian system chiller is supplied with the following features as standard:

- Rotationally moulded inner & outer polypropylene tank offering long life and corrosion resistance.
- The tank is insulated with environmentally responsible, water blown non-CFC polyurethane insulation.
- A second thermostat probe is attached to the evaporator suction line. This probe will shut down the refrigeration system should the suction line temperature drop below normal operating conditions.
- Airtight design of the tank & lid keeps condensation to a minimum to eliminate dilution of the glycol solution.
- Tank moulded legs allow easy cleaning under the unit once installed.
- Semi-submersible, single phase pump.
- Operates using environmentally responsible R404a refrigerant as standard.

- Offers low installation, operating and maintenance costs due to single phase (230V 50Hz)
- power requirement to operate both the refrigeration and pump.

1.4 Pump curve

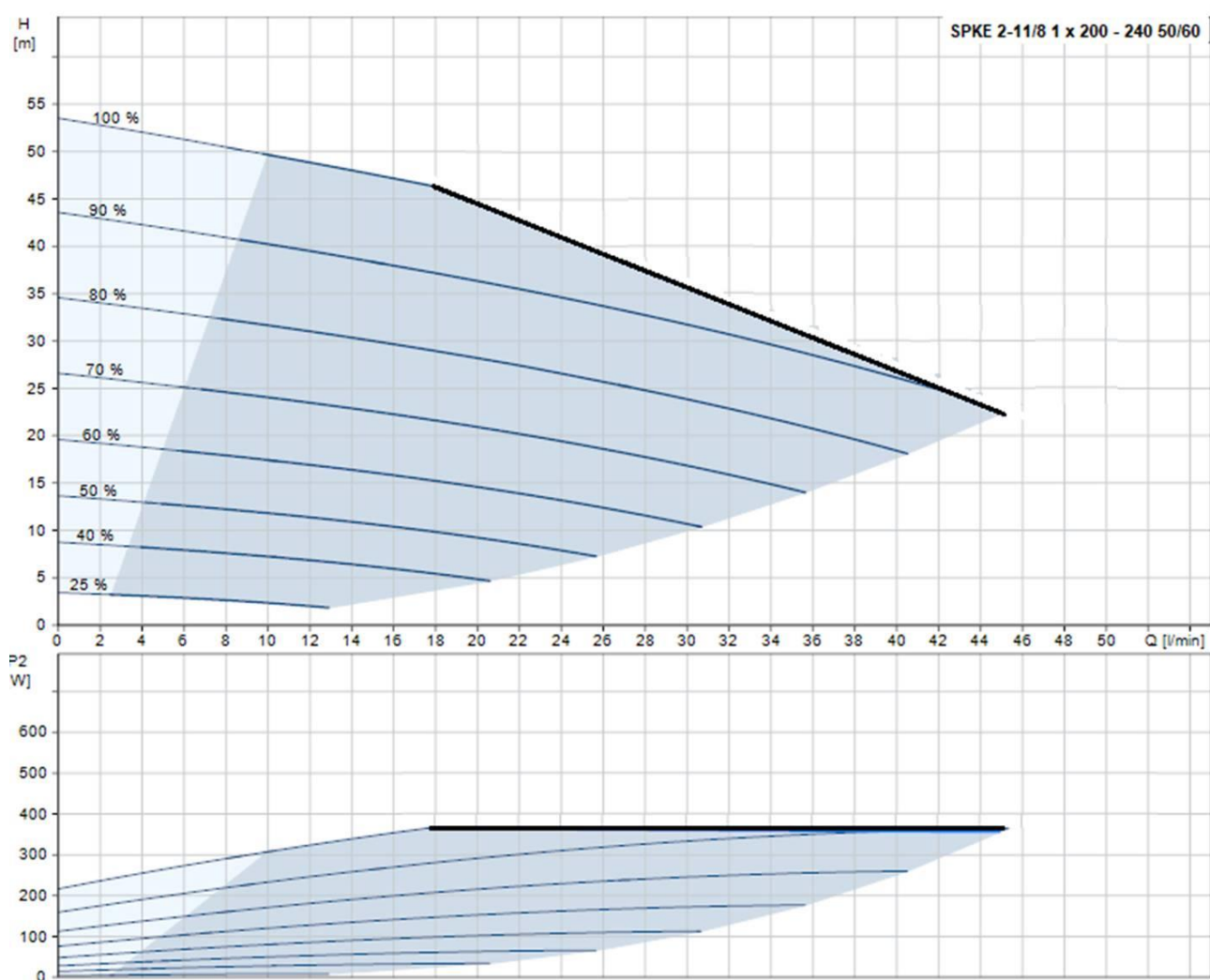

2. Safety Information

1.5 Safety Instructions

For your personal safety, and that of others working around you please read, understand, and follow thoroughly all safety instructions included in this manual and on the Siberian unit.

- Review all applicable WHS (Work Health & Safety) regulations
- Learn how to operate the Siberian Glycol Chiller and use the controls properly.
- Do not allow untrained personnel to operate the machine.
- Ensure that the Siberian Glycol Chiller is maintained according to service manual instructions.
- Do not allow any unauthorized modifications to the machine.

1.6 Recognize Safety Alert Symbols

The safety alert symbol precedes Warning and Caution notes throughout this manual. To prevent personal injury or damage to the machine these alerts must be strictly adhered to.

	Warning	Alerts to a potentially hazardous situation that if not avoided CAN result in death, serious injury.
---	----------------	--

	Caution	Alerts to a potentially hazardous situation that if not avoided MAY result in injury or equipment damage.
---	----------------	---

1.7 Operating

	Warning	Siberian VSD Glycol Chiller are intended for indoor operation only; do not operate outside unless suitably protected by a weatherproof enclosure. This appliance is not suitable for installation in an area where a water jet could be used.
---	----------------	---

	Caution	This appliance is not intended for use by persons (including children) with reduced physical, sensory or mental capabilities, or lack of experience and knowledge, unless they have been given supervision or instruction concerning use of the appliance by a person responsible for their safety. Children should be supervised to ensure that they do not play with the appliance.
---	----------------	---

	Caution	This appliance is intended to be used in commercial applications such as restaurants or similar.
---	----------------	--

1.8 Service & Maintenance

	Caution	Installation of Siberian VSD Glycol Chiller and service work should only be performed by fully trained & certified Electrical, Plumbing, & Refrigeration Technicians.
---	----------------	---

	Warning	All wiring and plumbing must conform to local and national codes.
---	----------------	---

	Warning	The Siberian VSD Glycol Chiller must be isolated from electrical supply before commencing any service or maintenance work.
---	----------------	--

3. Installation instructions for:

31000254 SIBERIAN 5 KW R404 SPKE2-11/8 or 31000254 SIBERIAN 5KW R404 SPKE2-11/8



Warning

To avoid personal injury, use correct manual handling techniques and lifting equipment.

1.9 Receiving

Each unit is completely tested under operating conditions and thoroughly inspected before shipment. At time of shipment, the carrier accepts the unit and any claim for damage(s) must be made with the carrier. Upon receiving units from the delivering carrier, carefully inspect shipping crate for visible indication(s) of damage. If damage exists, have carrier note damage on bill of lading and file a claim with the carrier.

1.10 Unpacking



Caution

The use of gloves is recommended to protect hands from potential injury from sharp edges.

Carefully unpack the Lancer Siberian VSD Glycol Chiller from the shipping carton. Inspect unit for concealed damage and if evident, notify delivering carrier and file a claim against the carrier.

1.11 Selecting a Location



Warning

Siberian VSD Glycol Chiller are intended for indoor operation only; do not operate outside unless suitably protected by a weatherproof enclosure. This appliance is not suitable for installation in an area where a water jet could be used.



Warning

When positioning the appliance, ensure the supply cord is not trapped or damaged. Do not locate multiple portable socket-outlets or portable power supplies at the rear of the appliance.



Caution

The Siberian VSD Glycol Chiller is not suitable for use in subfreezing temperatures.



Caution

The Siberian VSD Glycol Chiller is only to be installed in locations where its use and maintenance is restricted to trained personnel.

Select a level, well ventilated, accessible location convenient to water and electrical supply, which can support a weight of 200kg.

1.12 Connecting to the Venue's Glycol Cooling System

Connect glycol lines from the supply manifold direct to pump. Figure 1 (A)
Return manifold to glycol return pipe via return solenoid. Figure 1 (B)
After leak checking, ensure lines are fully insulated.

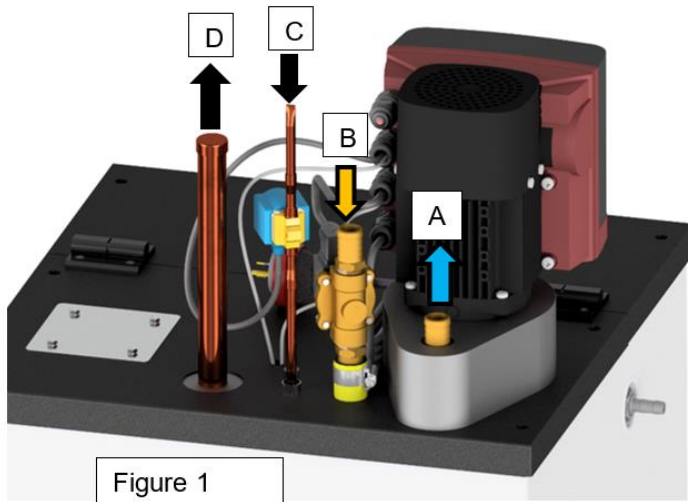
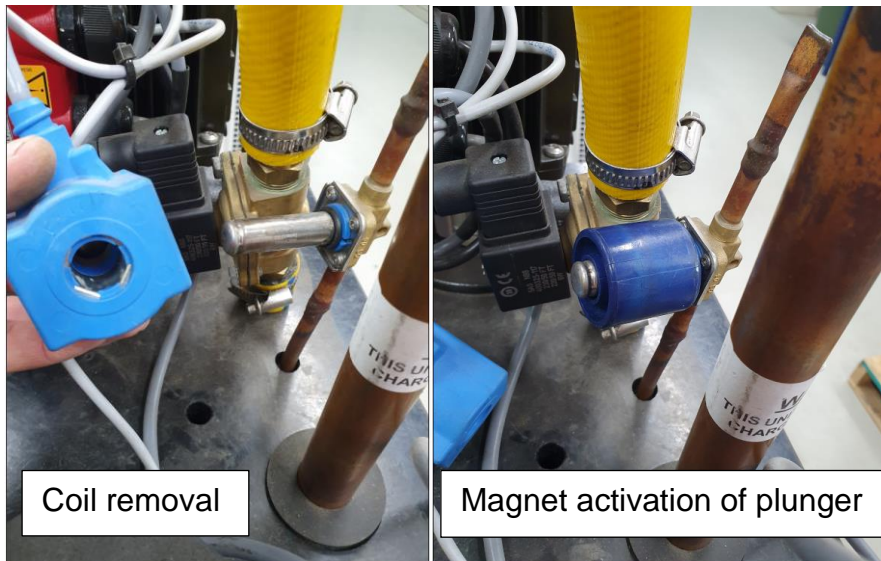

Figure 1

1.13 Refrigeration Connection

As with all installations, good refrigeration practice is necessary to ensure reliability and satisfactory performance of the Siberian VSD Glycol Chiller.
All units have a holding charge of Nitrogen. Ensure the solenoid is active prior to evacuation.

It is recommended that an external solenoid magnet is used to open the solenoid. To do this, lever the coil from the plunger shaft with a screwdriver and place the magnet over the plunger shaft and confirm the plunger retracts via an audible click. Failure to do so may result in poor evacuation of the refrigeration system and possible system failure.



Coil removal

Magnet activation of plunger

The solenoid can also be activated by switching the pump on and making sure glycol bath temperature (Temperature 1) is above -2°C. This will activate the refrigeration solenoid. This is only recommended if the tank is full of water/glycol mix and the pump outlet is plumbed back into the inlet side, so the pump does not run dry during the brazing process.



Temperature 1 is the glycol bath temperature.





Recirculate the glycol to prevent pump running dry.

Particular care should be taken to prevent oxidation during brazing, by using dry nitrogen and to ensure that a thorough evacuation of the system is carried out prior to gas charging. We recommend that isolating valves are fitted to the refrigerant pipes adjacent to the unit and that the refrigeration be connected to a dedicated and correctly sized condensing unit. Fully insulate suction line Figure 1 (D). Liquid line Figure 1 (C).

1.14 Electrical Connection

This unit is connected to the supply via a 10 amp flexible cord fitted with a Splashproof IP66 3 pin plug. Check the name plate on the machine for electrical supply requirements. Use only the power supply specified on the name plate.

	Warning To prevent possible electrical shock or extensive damage to the unit, the appliance must be connected with the flexible cord supplied with the appliance to an appropriate electrical outlet socket installed in accordance with local codes and regulations i.e. AS/NZS 3000.
---	--

	Warning If the supply cord is damaged, it must be replaced by the manufacturer, its service agent or similarly qualified persons with a replacement cord available from Lancer Parts/Service Centres.
---	---

**Caution**

In order to avoid a hazard due to inadvertent resetting of the thermal cut out, this appliance must not be supplied through an external switching device, such as a timer, or connected to a circuit that is regularly switched on and off by the utility.

1.15 Filling Unit with Glycol / Water

**CAUTION**

Ensure glycol is added first, then water, prior to starting the refrigeration system – failure to do so will cause severe damage to the plate heat exchanger and refrigeration system and will void all warranty.

The Siberian VSD Glycol Chiller requires a 30% glycol / water mixture (see concentration chart on page 11 for details). Put 48 litres of glycol in the tank and fill with water until the glycol / water mixture reaches the overflow.

The overflow should be plumbed away to a suitable drain or container, via a Goose neck connection.

**CAUTION**

Only use propylene glycol for freeze point depression. The use of other chemicals may damage equipment and pose a health risk.

1.16 Commissioning

Ensure refrigeration condensing unit is turned off to prevent heat exchanger plate becoming too cold and freezing glycol on initial return.

Turn power on to the Siberian VSD Glycol Chiller and allow the python glycol lines to fill. Ensure liquid level does not drop below pump intake during initial filling of python.

As required, top up the unit with a premixed 30% glycol / water mixture to correct level. Check water / glycol mixture with refractometer.

Turn on refrigeration condensing unit. If glycol bath temperature is above the set point of the thermostat the refrigeration solenoid should be operational.

Check all connections for leaks.

Monitor the indicated temperature on the pump display panel and ensure temperature reduces to the set point.

Skip to section 5 Operation



Warning

Do not connect Siberian VSD Glycol Chiller to a hot water or soft water source.

4. Installation Instructions for: 78000136 KIT C/O SPKE211 VSD SUIT SIB

The kit is suitable for retrofitting to an existing Siberian unit with a standard Grundfos SPK2-11 pump.

Turn off the power at the outlet and unplug the unit.

Isolate the return glycol and supply lines to prevent drainage of the system.

Disconnect the glycol supply line from the existing pump (keep the hose clamp).

Disconnect the glycol return line from the solenoid barb fitting (keep the hose clamp).

Remove the pump, glycol return solenoid, the coil only from the refrigeration solenoid, the electrical box and the attached temperature sensors from the bath and suction line.

Install the new pump.

Remove the M16 grommet from the thermocouples and install into the M14 hole in the lid in front of the refrigeration pipes. This can be achieved, ideally by tapping the hole with an M16 x1.5 tap or alternatively carefully hammering the M16 threaded grommet into the unthreaded hole with a rubber mallet.

Feed the smaller suction line thermocouple through the grommet and attach (cable tie) to the top surface of the suction line and wrap tightly with "air tape" or other suitable thermal insulation cork tape.

Feed the bath temperature thermocouple through the same M16 grommet up to the heat shrink and carefully tighten to clamp. The bath thermocouple should extend vertically into the bath and be secured just enough to minimise movement.

Reconnect both glycol lines and reverse the isolation method.

Connect the pump to the mains power via the 10 amp plug and turn on the power outlet.

5. Operation

The SPKE 2-11-8 MGE drive pump is preprogrammed at the factory. The system is operated from the switch (on/off) at the power supply outlet on the wall of the venue. The key pad on the pump front panel is locked to adjustments. There are no operating parameters to set or adjust in the field.

The keyboard on the motor is locked for two reasons:

- 1) to prevent changes being made by unqualified people and
- 2) to isolate the on off button on the pump.

To turn the unit off, as might be needed during a line clean, the switch on the power outlet must be turned off. This prevents the pump being shut down and the refrigeration continuing to be active (possibly leading to a frozen heat exchange).

The motor has two temperature inputs and the control system uses the limit exceeded function for both inputs to cycle the refrigeration and to provide a low temp alarm (freeze up alarm).

Temp 1 is the glycol bath probe and is set up so that above -1.7°C the motor will run at 2,750 rpm and the refrigeration solenoid will open. When the bath temperature drops below -2.7°C the refrigeration solenoid will be turned off and the motor reverts back to the pre-set speed of 1700 rpm.

In a low temperature situation (Temp 2 suction line temp of -7°C) the glycol bath probe is ignored, and the refrigeration solenoid is closed. The pump motor will go into alarm (on the display) and operate at min speed (1700 rpm). A warning is shown on the display as a rotating orange light. This means the pump will continue to operate preventing the glycol from flooding back via the open glycol solenoid and also continues to provide some flow and load from the system to aid defrosting of the heat exchanger.

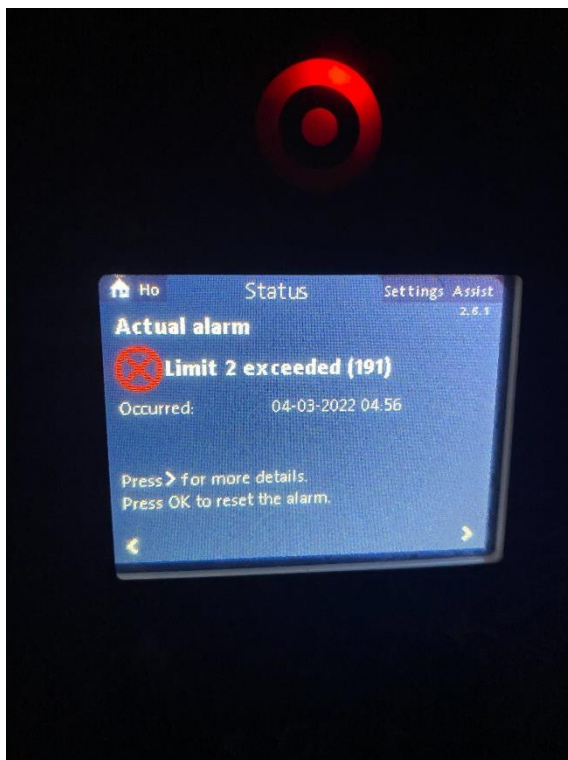

A suction line temperature of 10°C should ensure any ice has been thawed if the cause of the alarm is a freeze up of the HX. The system will recommence standard operation if the suction line probe records a temperature above $+10^{\circ}\text{C}$.

If the venue requires full pump flow for any reason an override push button is located behind the pump above the electrical lead entry points. The refrigeration system will be unaffected by this change. Press the button again and it will unlatch, returning the system to standard

programmed mode. The difference in button position (in/pressed/latched or out/standard/unlatched) can be seen by a difference in button height by the user.

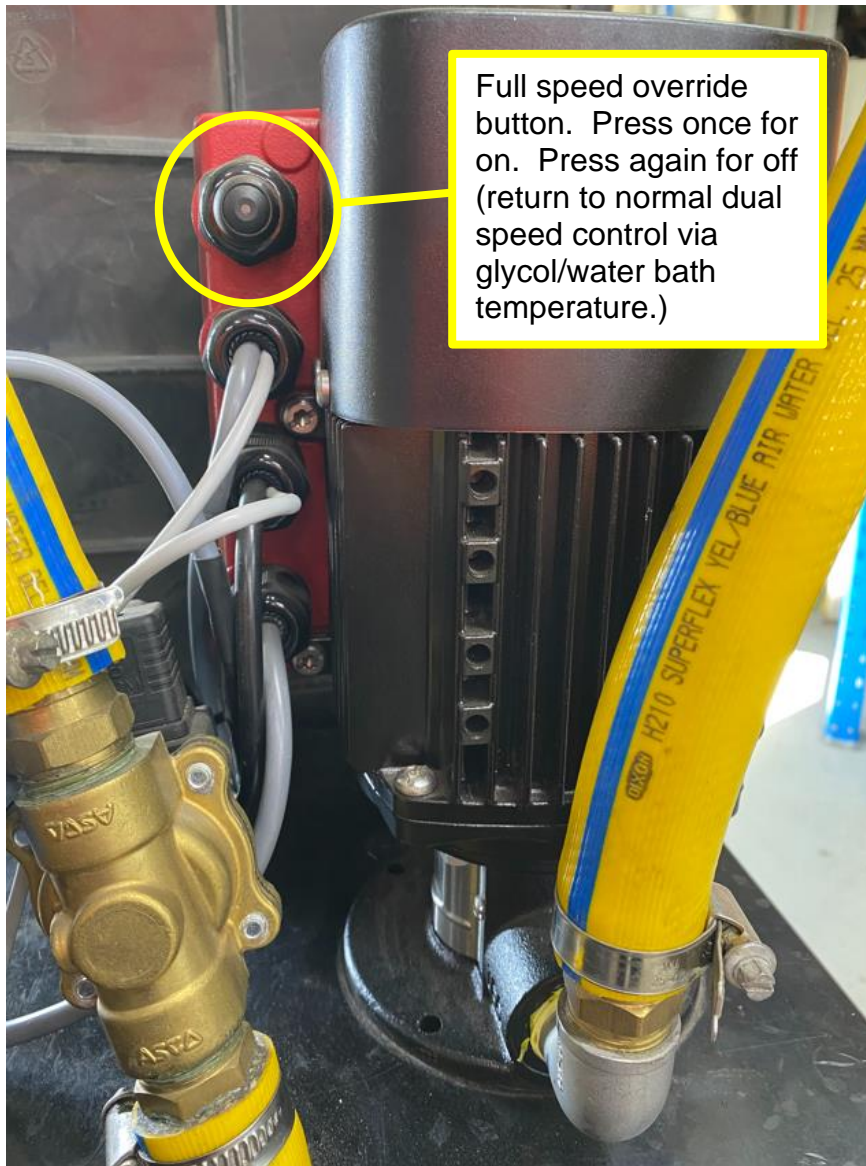



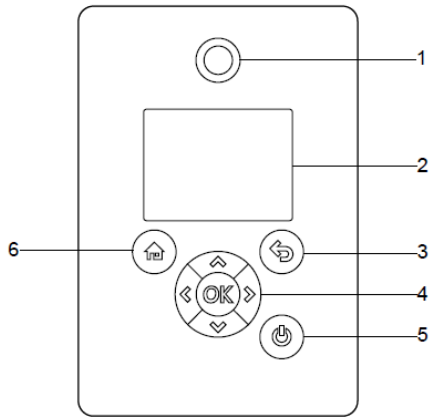



The features on the front panel of the MGE drive are shown below. All buttons are locked.



Pos.	Symbol	Description
1		Grundfos Eye: The indicator light shows the operating status of the product.
2	-	Graphical colour display.
3		Back: Press the button to go one step back.
		Left/Right: Press the buttons to navigate between main menus, displays and digits. When you change the menu, the display shows the top display of the new menu.
		Up/Down: Press the buttons to navigate between submenus or change the value settings. If you have disabled the possibility to make settings with the Enable/disable settings function, you can enable it again temporarily by pressing these buttons simultaneously for at least 5 seconds.
4		OK: Press the button to do as follows: <ul style="list-style-type: none"> • save changed values, reset alarms and expand the value field • enable radio communication with Grundfos GO Remote and other products of the same type. OK When you try to establish radio communication between the product and Grundfos GO Remote or another product, the green indicator light in Grundfos Eye flashes. In the controller display, a note states that a wireless device wants to connect to the product. Press OK on the product operating panel to allow radio communication with Grundfos GO Remote and other products of the same type.
5		Start/Stop: Press the button to make the product ready for operation or to start and stop the product. Start: If you press the button when the product is stopped, the product starts if no other functions with higher priority have been enabled. Stop: If you press the button when the product is running, the product always stops. When you press the button, the stop icon appears at the bottom of the display.
6		Home: Press the button to go to the Home menu.

Grundfos Eye indicator light

Indicator light	Description
	No lights are on. The power is off. The motor is not running.
	Two opposite green indicator lights are rotating. The power is on. The motor is running. The indicator lights are rotating in the direction of rotation of the motor when seen from the non-drive end.
	Two opposite green indicator lights are permanently on. The power is on. The motor is not running.
	One yellow indicator light is rotating. Warning The motor is running. The indicator light is rotating in the direction of rotation of the motor when seen from the non-drive end.
	One yellow indicator light is permanently on. Warning The motor has stopped.
	Two opposite red indicator lights are flashing simultaneously. Alarm The motor has stopped.

Functional Summary

The pump operates at 2,750 rpm during the refrigeration on cycle and slows down to 1,700 rpm when the refrigeration is off.

The preprogrammed temperature set points are:

Temperature 1, Glycol Bath Temperature set -2.7°C with hysteresis band 1°C.

Above limit action – pump speed 2,750 rpm and signal relay 2 to run (open refrigeration solenoid)

Temperature 2, Suction line Temperature Limit set -7°C with hysteresis band 17°C.

Below limit action – Alarm, pump speed 1,700 rpm and refrigeration solenoid closes.

Temperature 1 input ignored.

Pump runs slowly to add heat to assist in defrosting frozen glycol tank.

Once +10°C is reached the alarm is cancelled, allowing control of the system via Temperature 1 input (water bath temp), open refrigeration solenoid and run at high pump speed 2,750 rpm.

Refrigeration override switch

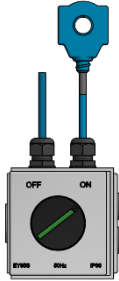

The refrigeration override switch allows for the cooling capacity of the Siberian elite to be terminated, while leaving the VSD pump operational.

Switching the override switch to 'OFF' will **terminate the supply of power to the refrigeration solenoid** of the Siberian unit.

6. Scheduled Maintenance

5.1 Monthly

Check water/glycol level.

Check water/glycol concentration using refractometer (see chart).

Relative freeze points and refractometer readings for propylene glycol / water mix

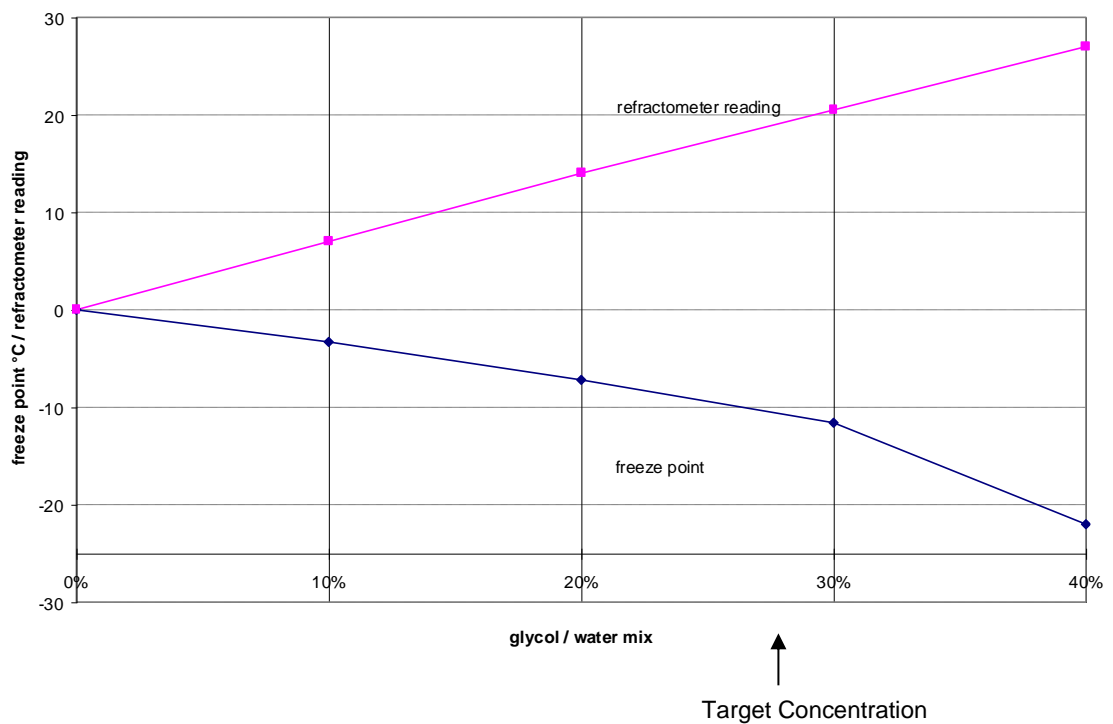

7. Electrical Circuit Diagram

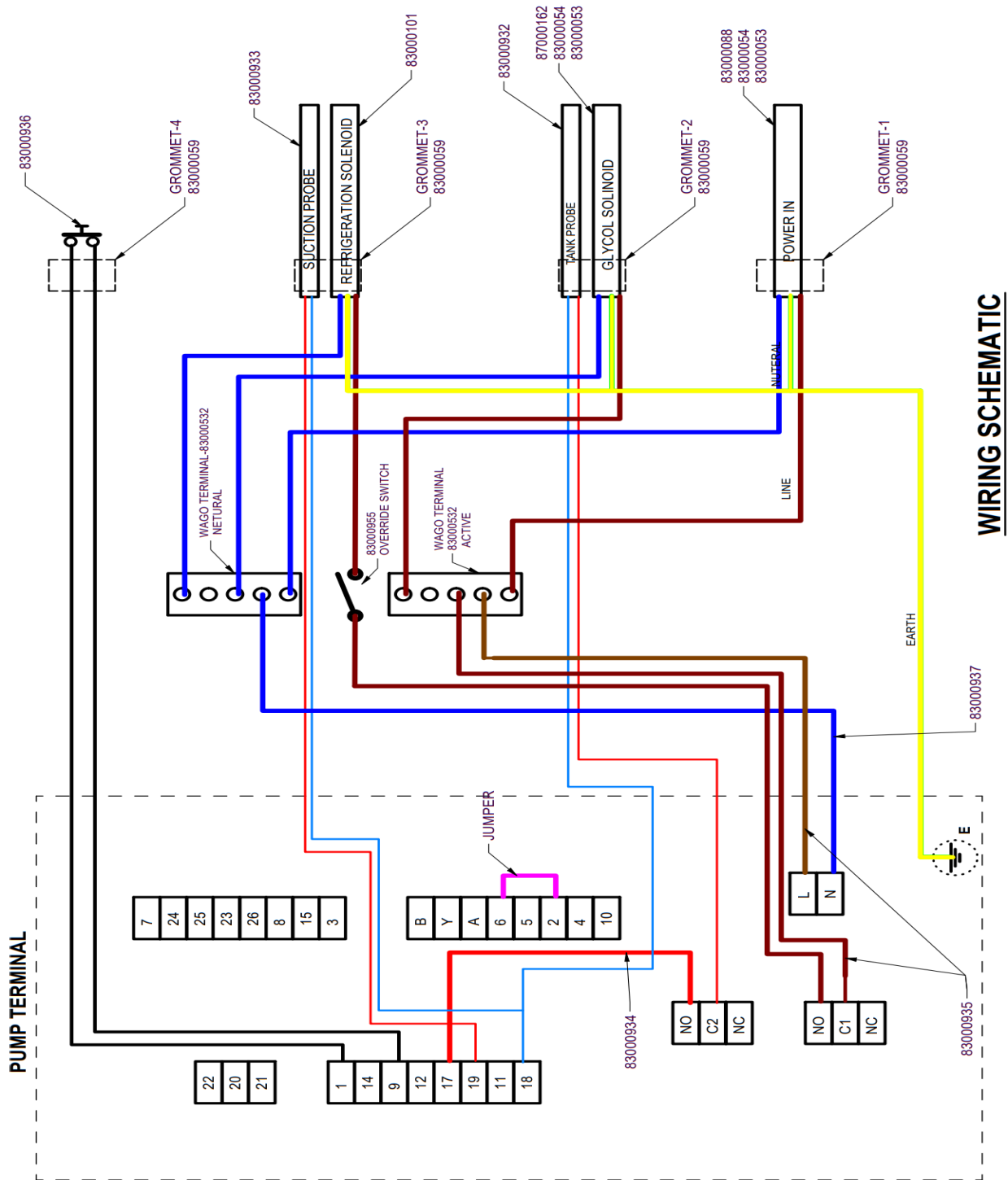

WIRING SCHEMATIC

8. Diagrams & Parts

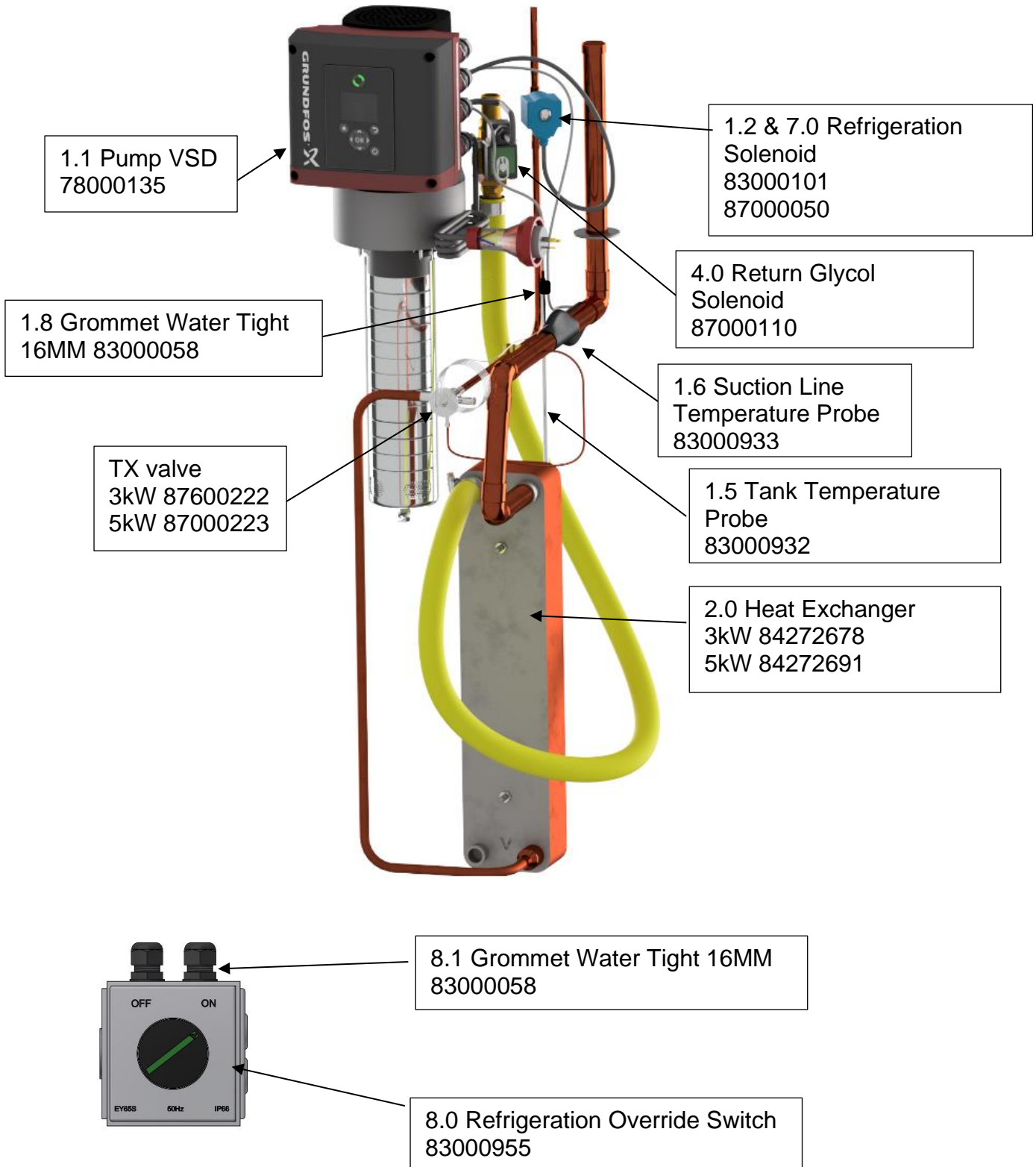

31000254 SIBERIAN 5KW R404 SPKE2-11/8
 31000255 SIBERIAN 3KW R404 SPKE2-11/8

SPARE PARTS LIST			
ITEM	QTY	PART NUMBER	DESCRIPTION
1	1	78000136	KIT C/O SPKE211 VSD SUIT SIB
1.1	1	78000135	PUMP SPKE2-11/8 GRUNDFOS VSD
1.2	1	83000101	SOLN COIL DANFOSS W/ LEAD
1.3	1	87000162	COIL ONLY SUITS ASCO 3/4 SOL
1.4	1	83000088	PLUG SCREWED RING 3 PIN 56P310
1.5	1	83000932	PROBE PT100 SUIT SPKEVSD 300MM
1.6	1	83000933	PROBE PT100 SUIT SPKEVSD 70MM
1.7	1	83000936	ASSY BUTTON MAX RUN SPKEVSD
1.8	1	83000058	GROMMET WATER TIGHT 16MM
2.0	1	84272691	HEAT EXCHANGER 26 PLATE 5KW
2.0	1	84272678	HEAT EXCHANGER 18 PLATE 3KW
4.0	1	87000110	SOLENOID AND COIL 3/4
5.0	1	81000172	HOSE PVC SUPERFLEX 25MM 100MT
6.0	1	87600223	TX VALVE TUBE 08 R404 EXT
6.0	1	87600222	TX VALVE TUBE 07 R404 EXT
7.0	1	87000050	SOLN EVR3 3/8 WELD IN DANFOSS
8.0	1	83000955	REFRIGERATION OVERRIDE SWITCH (EY56S)
8.1	1	83000058	GROMMET WATER TIGHT 16MM

9. Trouble Shooting

TROUBLE	CAUSE	REMEDY
Condensing unit will not start.	<p>Power Failure</p> <p>Pumps not active</p> <p>Thermostat probe failure</p> <p>Solenoid coil failure</p>	<p>Check for blown circuit breaker or cord pulled out.</p> <p>Replace</p> <p>Replace solenoid</p>
Beer Warm	<p>Glycol bath temp outside control set points (-3°C and -1°C)</p> <p>Suction line hand valve (if fitted) is closed</p> <p>Faulty glycol pump</p> <p>Faulty TX valve</p> <p>Incorrect glycol concentration (or poor agitation)</p> <p>Hot keg used</p> <p>Refrigeration solenoid override switch set to off.</p>	<p>Confirm refrigeration solenoid is open and pump is running at 2,750 rpm.</p> <p>Open hand valve</p> <p>Replace pump</p> <p>Replace TX valve</p> <p>Check with refractometer & adjust</p> <p>Store next keg to be used in cool place</p> <p>Adjust the override switch to the ON position. (Override switch set to off will result in no refrigeration effect from the Siberian unit).</p>
No product flow	Frozen product line	Confirm refrigeration solenoid is closed and pump is running at least 1,700 rpm.
Noise evident	Noisy pump	Replace/repair pump
No glycol flow	Frozen HX plate	Confirm refrigeration solenoid is closed and pump is running at 1,700 rpm

TROUBLE	CAUSE	REMEDY
	Low glycol level Low glycol %	System leak Add glycol

10. Certificate of Warranty

It is the policy of Hoshizaki to provide to its current customers, warranty for all equipment supplied and installation work performed within a specified period.

Parts and Equipment

Lancer provides a warranty period of twelve (12) months from the date of original invoice for all manufactured parts. Repair or replacement of defective parts will be at the sole discretion of Lancer.

Changeover parts will be invoiced to the customer at the customers normal purchase cost and upon return of the warranty item and validation of the claim, the invoice will be credited.

Installations

Lancer provides a warranty period of twelve (12) months from the date of final invoice for workmanship after the completion of any installation work, provided the parts and labour are completed by Lancer or its subcontractor.

Labour

Lancer will not normally cover any labour costs associated with a warranty claim. Subject to the approval of the Divisional Sales Manager, Lancer may choose to reimburse the customer for some or all labour costs associated with a warranty claim. Any claim for labour costs must be authorized by Lancer prior to the work being undertaken.

Exclusions

Lancer will not accept any liability or cost associated with any consequential losses (such as loss of syrup or beer), loss of profit or damage to property as a result of faulty product.

Warranty shall not apply:

- a) If in the opinion of Lancer, the equipment has been used in a situation the equipment has not been designed for;
- b) If in the opinion of Lancer, the equipment has been subject to abuse, negligence or accident;
- c) If connected to improper, inadequate or faulty power, water or drainage service or operated using incorrect, insufficient or contaminated lubricants, coolants, refrigerants or additives;
- d) Where the product is installed, maintained or operated otherwise than in accordance with the instructions supplied by Lancer;
- e) Where the product has been damaged by foreign objects;
- f) Where the product has been serviced, repaired, altered or moved otherwise than by Lancer or its nominees or using other than Lancer approved replacement parts.

To obtain full details of your warranty and approved service agency, please contact your dealer/supplier, or the nearest Hoshizaki Office.

Hoshizaki Lancer TEL: +61 8 8268 1388 FAX: +61 8 8268 1978

11. Manufacturer's Checklist

- Evacuate, charge with nitrogen and leak check all refrigeration components.
- Liquid line and glycol solenoid installed in the correct flow direction.
- TX valve refrigerant matches unit.
- TX valve sensing bulb is secured tightly and in correct position, TX valve capillary not rubbing on anything.
- Air tape around TX bulb.
- Turn on unit, check thermostat operates and solenoids energise.
- Confirm the Refrigeration Override Switch de-energises the refrigeration solenoid. (Return to the ON position)
- Glycol probe in correct position and suction line probe checked for sensor tightness.
- Display screen content has been setup
- Check pumps operate.
- Check wiring to ensure no exposed wires.
- All refrigeration tube work straight and not rubbing on other components.
- Installation kit supplied.
- Decals and Serial number plaque correctly positioned.
- Tank area clean.
- Supply manual.
- All screws secure, ensure deck and lid are fully sealed.
- Supply original checklist to unit, file copy.

Electrically Tested By:

Inspection Number:

Electrical Continuity

Earth Continuity

Insulation

Checked by:

Date:.....

Work Order No:

